

BS5143-0

Field-Wireable Connector

Male Connector M8 × 1/Ø 8 mm, Straight

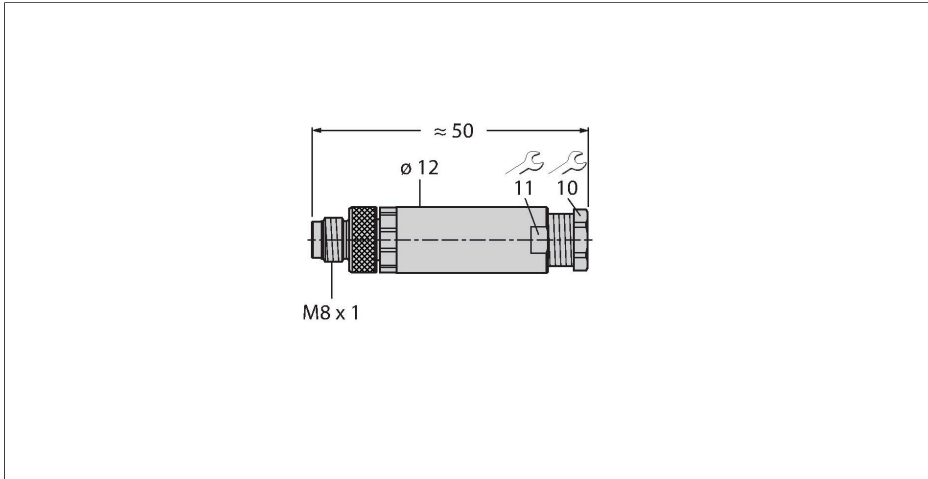

Features



- Metal coupling nut
- Protection class IP67
- Schraub-Klemmanschluss
- Field-wireable connector
- Mechanical connection M8/Ø 8 mm
- Straight design
- 4-pin
- metr. Screw-in thread M11 × 0.75
- Cable feedthrough 3.5...5.0 mm

Contact assignment



Technical data

Type	BS5143-0
ID	6901013
Connector A	Male, M8 × 1, Straight
Number of Pins	4
Contacts	Brass, CuZn, Gold-plated
Contact carriers	Plastic, PA 66 (UL 94 HB), Black
Connector body	Plastic, PBT, Black
Coupling nut/screw	Die-cast Zinc, GD-Zn, Nickel-plated
Screw-in thread seal	plastic, FPM/FKM
Screw-in thread	M11 × 0.75
External diameter of the cable	3.5...5 mm
Core cross-section/Clamping ability	0.14...0.5 mm ²
Connection mode	Screw/clamp connection
Mechanical lifespan	> 100 Mating cycles
Protection class	IP67, (screwed together)
Electrical properties at +20 °C	
Rated voltage	30 V
Current	4 A
forward resistance	≤ 3 mΩ
Mechanical and chemical properties	
Ambient temperature range (stationary)	-40...+85 °C
Ambient temperature range (In motion)	-40...+85 °C